

PRODUCT SPECIFICATION

Model No.: CSOS-S39126 CSOS-S39127

Descriptions:
<ul style="list-style-type: none"> ■ 0.39 Inch Single Digit Display ■ CSOS-S39126 is Common Anode ■ CSOS-S39127 is Common Cathode ■ Emitting Color: Blue ■ Standard: -11: Gray face, white segment. -21: Black face, white segment.



CUSTOMER APPROVED SIGNATURES	APPROVED BY	CHECKED BY	PREPARED BY

OPTO PLUS TECHNOLOGIES CO.,LTD
 Address:No.696,Yangming North Rd,
 ShaoXing City,ZheJiang Province, P.R.China.
 Tel :86-575-88623888
 Fax:86-575-88623112

Model No.: CSOS-S39126 CSOS-S39127

■ **Features -**

1. 0.39 inch (9.90mm) digit height
2. Qualified according to JEDEC moisture sensitivity Level 2a.
3. RoHS compliant.
4. Low power consumption.
5. Easy mounting on P.C. board .

■ **Device Selection Guide -**

Model No.	Chip	
	Material	Emitting Color
CSOS-S3912xB	InGaN	Blue

■ **LED Numeric/Alphanumeric Display**

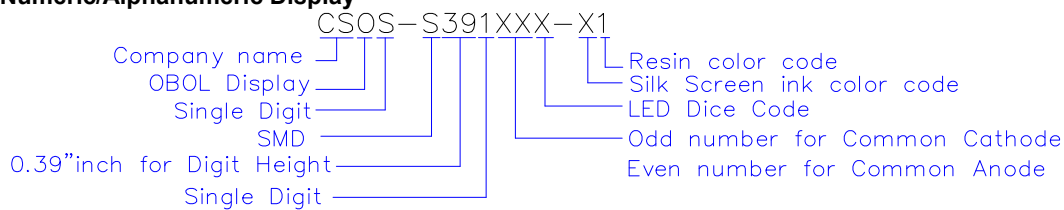

■ **Mechanical Dimensions -**

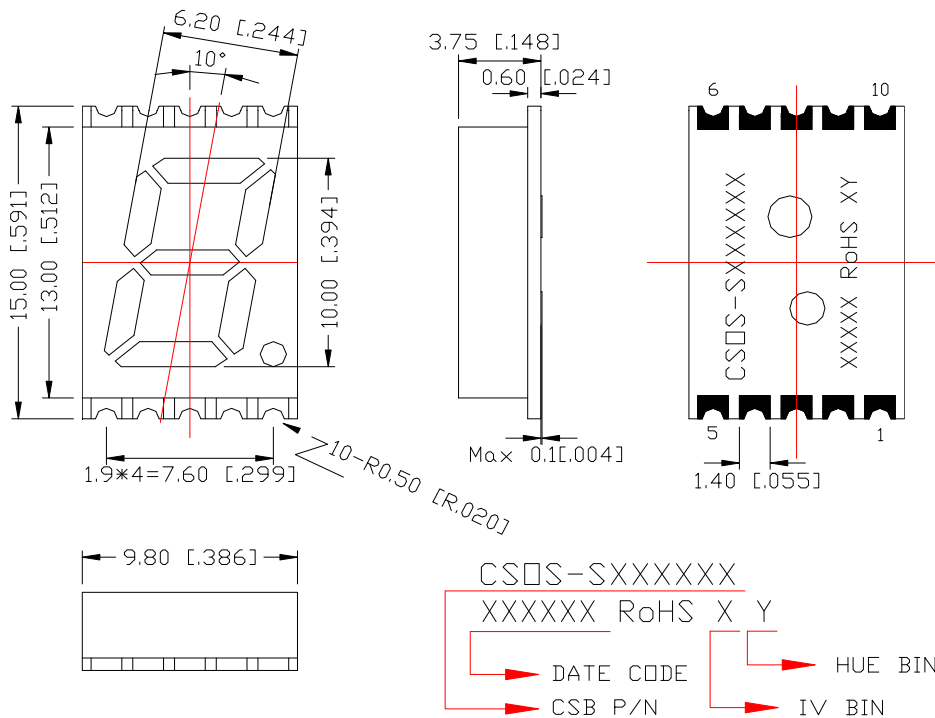

Notes:

1. Dimension in millimeter [inch], tolerance is ± 0.25 [.010] and angle is $\pm 1^\circ$ unless otherwise noted.
2. Bending \leq Length*1%.

Model No.: CSOS-S39126 CSOS-S39127

■ All Light On Segments Feature & Pin Position

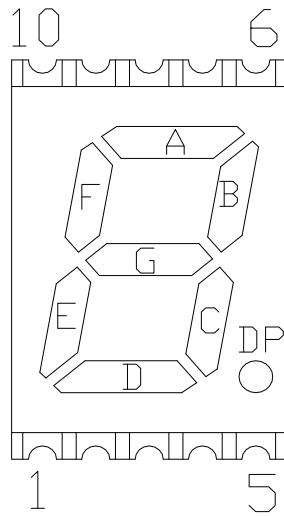

■ Internal Circuit Diagrams -

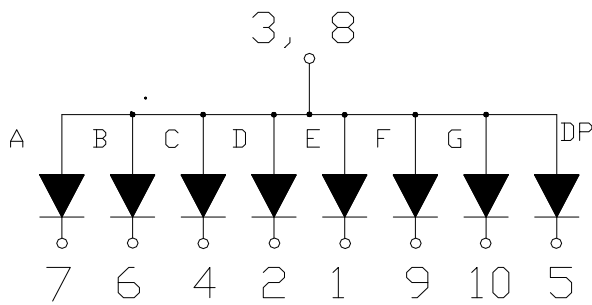

CSOS-S39126 is Common Anode

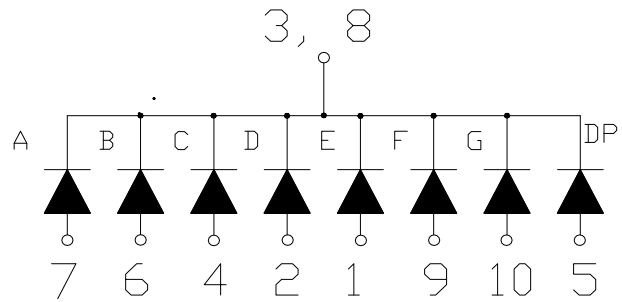

CSOS-S39127 is Common Cathode

Model No.: CSOS-S39126 CSOS-S39127

■ Absolute Maximum Rating -

(Ta=25°C)

Parameter	Symbol	Rating	Unit
Power Dissipation Per Dice	P _{AD}	114	mW
Derating Liner from 25°C per Dice	-	0.4	mA/°C
Continuous Forward Current Per Dice	I _{AF}	30	mA
Peak Current Per Dice(duty cycle 1/10,1KHz)	I _{PF}	100	mA
Reverse Voltage Per Dice	V _R	5	V
Electrostatic discharge(HBM)	ESD	1000	V
Operating Temp.	T _{opr}	-40 ~ +105	°C
Storage Temp.	T _{stg}	-40 ~ +105	°C

■ Electro-optical Characteristics -

(Ta=25°C)

Parameter	Symbol	Min.	Typ.	Max.	Unit	Condition
Forward Voltage Per Segment	V _F	-	3.2	3.8	V	I _F =20mA
Luminous Intensity Per Segment	I _v	-	9	-	mcd	I _F =10mA
Dominant Wavelength	λ _d	-	465	-	nm	I _F =20mA
Reverse Current	I _R	-	-	50	μA	V _R =5V
Luminous Intensity Matching Ratio	I _{v-m}	-	-	2:1	-	I _F =10mA

Notes:The device can not operated under continuous reverse voltage.

■ Typical Electrical / Optical Characteristics Curves -

(Ta = 25°C Unless Otherwise Noted)

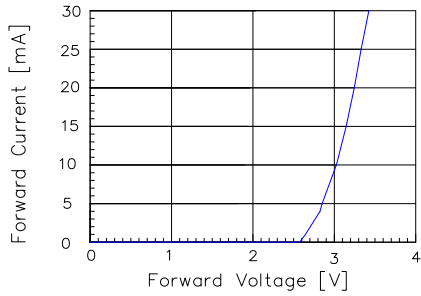

Fig 1. Forward Current vs. Forward Voltage

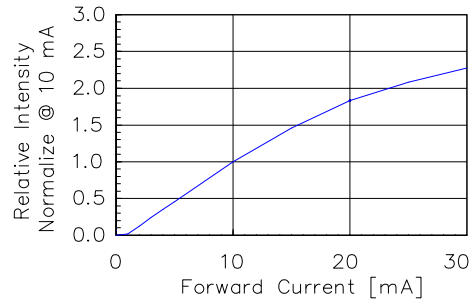

Fig 2. Relative Intensity vs. Forward Current

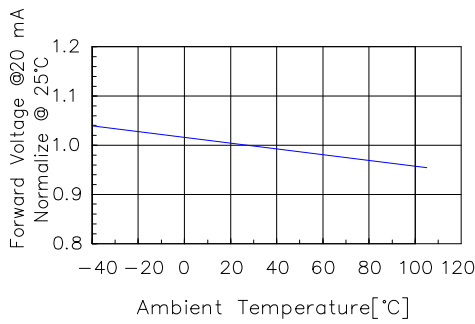

Fig 3. Forward Voltage vs. Temperature

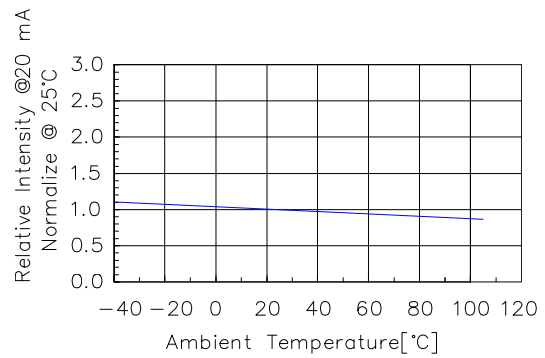

Fig 4. Relative Intensity vs. Temperature

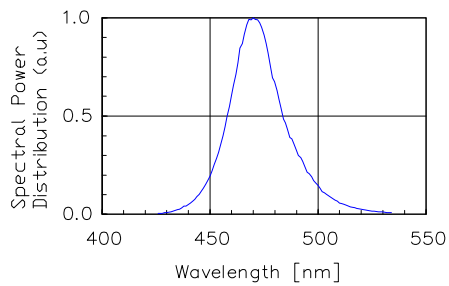

Fig 5. Spectral Power Distribution vs. Wavelength

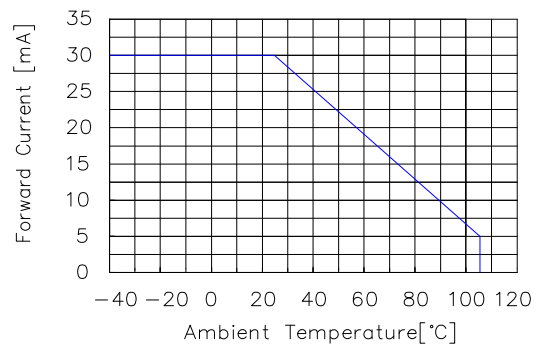
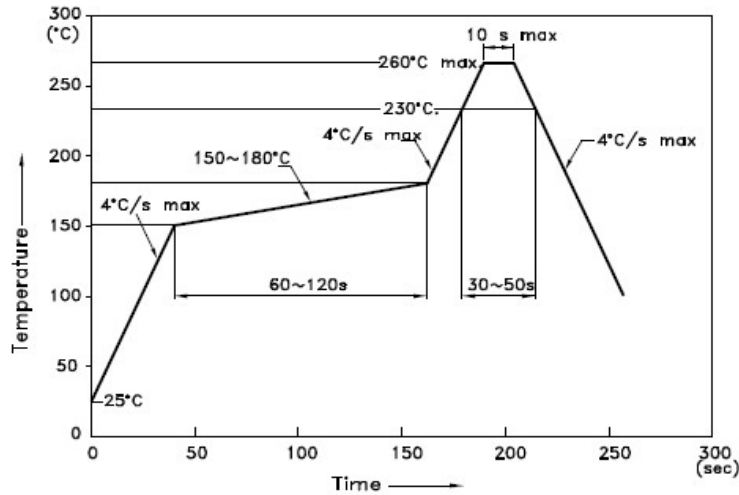

Fig 6. Forward current vs. Temperature

Model No.: CSOS-S39126 CSOS-S39127

SMT REFLOW SOLDERING INSTRUCTIONS

■ IR Reflow Temperature / Time :



NOTES:

1. We recommend the reflow temperature 245°C(+/-5°C). The maximum soldering temperature should be limited to 260°C.
2. Don't cause stress to the epoxy resin while it is exposed to high temperature.
3. Number of reflow process shall be 2 times or less.

■ Soldering Pad Size

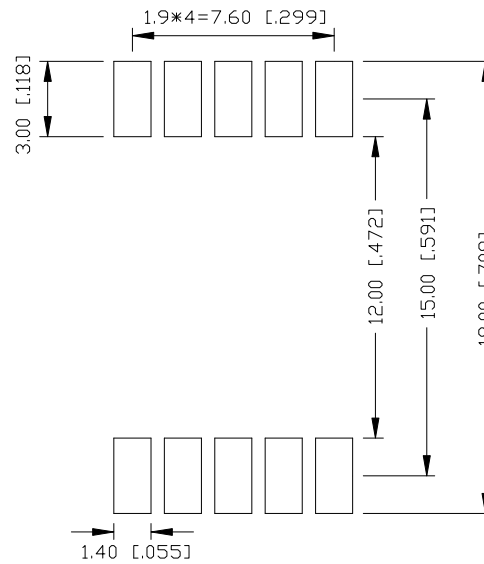

Model No.: CSOS-S39126 CSOS-S39127

REEL DIMENSIONS

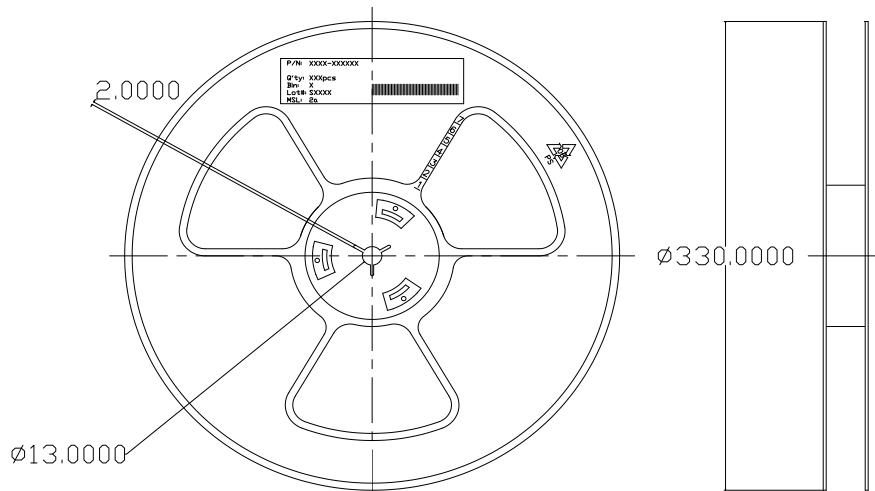

PACKING & LABEL SPECIFICATIONS

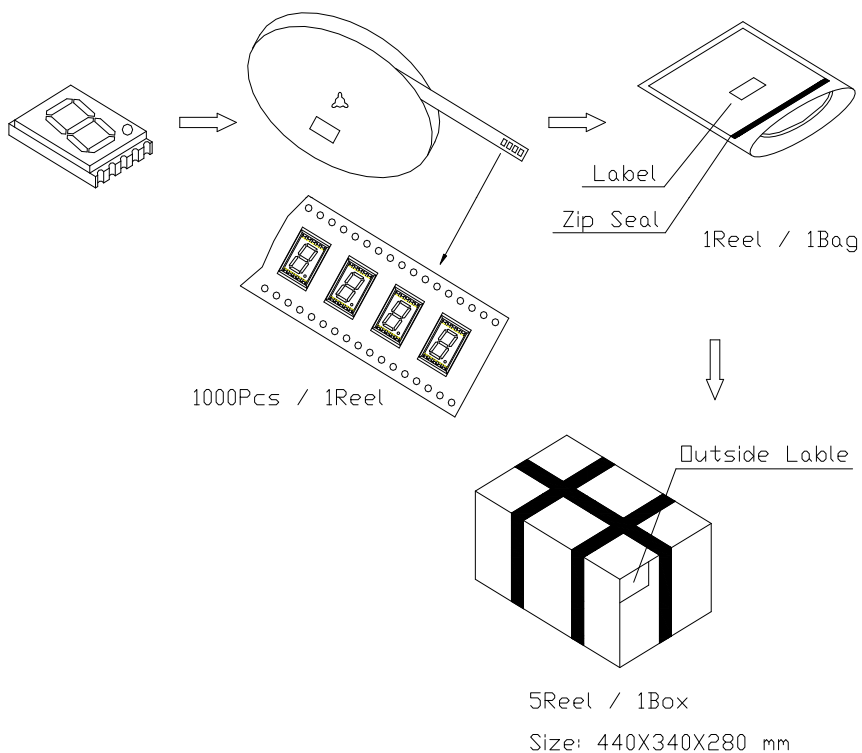

Note: The specifications are subject to change without notice. Please contact us for updated information.