

# PRODUCT SPECIFICATION

**Model No.: CSOS-80100W CSOS-80101W**

Descriptions:
<ul style="list-style-type: none"> <li>■ 0.8Inch Single Digit Display</li> <li>■ CSOS-80100 is Common Anode</li> <li>■ CSOS-80101 is Common Cathode</li> <li>■ Emitting Color: White</li> <li>■ Standard: -11: Gray face, white segment.                   -21: Black face, white segment.</li> </ul>



CUSTOMER APPROVED SIGNATURES	APPROVED BY	CHECKED BY	PREPARED BY

**OPTO PLUS TECHNOLOGIES CO.,LTD**  
 Address:696 Yang ming Rd.,Shaoxing,  
 ZheJiang,China.

Tel :86-575-88623888  
 Fax:86-575-88623112

**Model No.: CSOS-80100W CSOS-80101W**
**■ Features -**

1. 0.8 inch (20.40mm) digit height.
2. Case mold type.
3. RoHS compliant.
4. Low power consumption.
5. Easy mounting on P.C. board or socket.

**■ Device Selection Guide -**

Model No.	Chip	
	Material	Emitting Color
CSOS-8010XW	InGaN	White

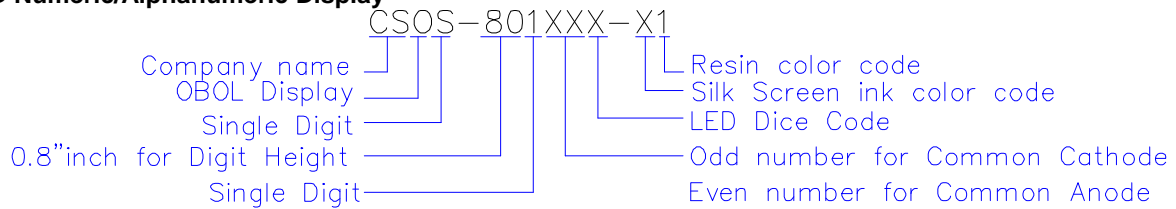
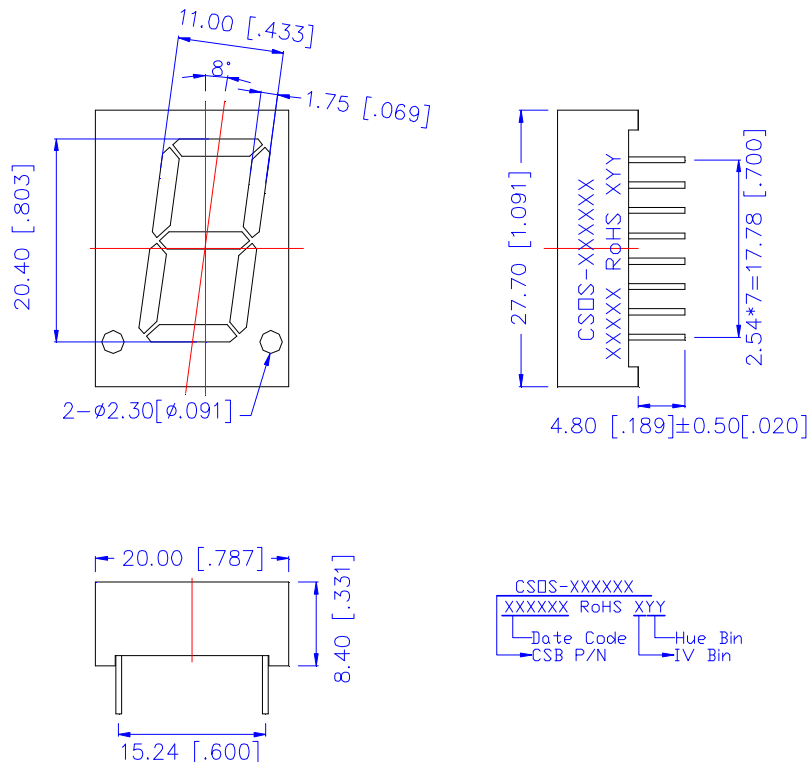
**■ LED Numeric/Alphanumeric Display**

**■ Mechanical Dimensions -**

**Notes:**

1. All pins are  $\Phi 0.50 [0.020] \pm 0.1 [0.004]$
2. Dimension in millimeter [inch], tolerance is  $\pm 0.25 [0.010]$  and angle is  $\pm 1^\circ$  unless otherwise noted.
3. Bending  $\leq$  Length\*1%.

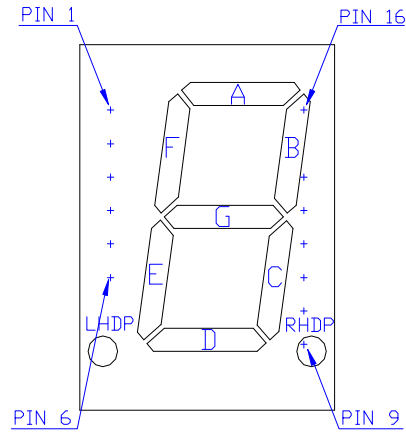
Model No.: CSOS-80100W CSOS-80101W

■ All Light On Segments Feature & Pin Position



■ Internal Circuit Diagrams -

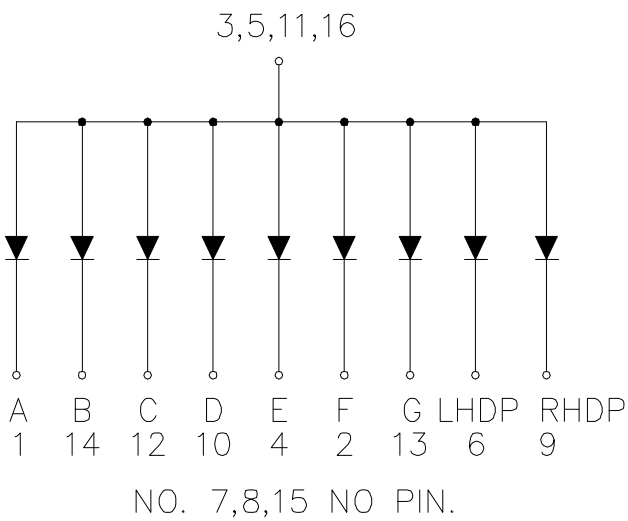

CSOS-80100 is Common Anode

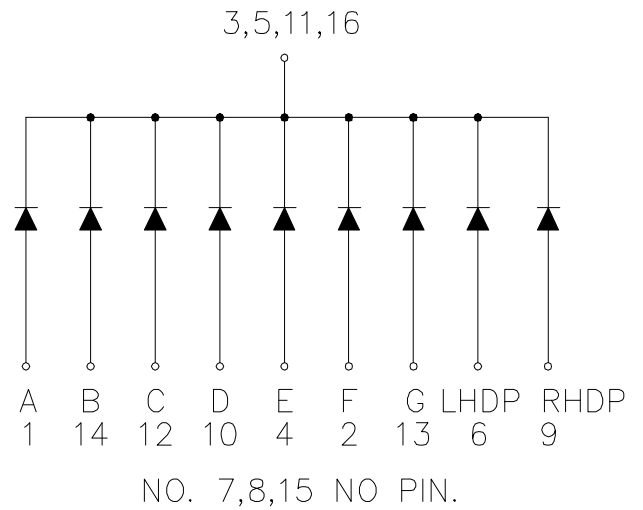

CSOS-56101 is Common Cathode

Model No.: CSOS-80100W CSOS-80101W

■ Absolute Maximum Rating -

(Ta=25°C)

Parameter	Symbol	Rating	Unit
Power Dissipation Per Dice	PAD	114	mW
Derating Liner from 25°C per Dice	-	0.4	mA/°C
Continuous Forward Current Per Dice	IAF	30	mA
Peak Current Per Dice(duty cycle 1/10,1KHz)	IPF	100	mA
Reverse Voltage Per Dice	VR	5	V
Electrostatic discharge(HBM)	ESD	1000	V
Operating Temp.	Topr	-35 ~ +85	°C
Storage Temp.	Tstg	-35 ~ +85	°C
Hand Soldering Temp.	Tsol	350	°C

■ Electro-optical Characteristics -

(Ta=25°C)

Parameter	Symbol	Min.	Typ.	Max.	Unit	Condition
Forward Voltage Per Segment	V <sub>F</sub>	-	3.2	3.8	V	I <sub>F</sub> =20mA
Luminous Intensity Per Segment	I <sub>v</sub>	-	150	-	mcd	I <sub>F</sub> =10mA
Chromaticity Coordinates (Tolerance: ±0.01)	x	-	0.27	-	-	I <sub>F</sub> =10mA
	y	-	0.25	-		
Reverse Current	I <sub>R</sub>	-	-	50	μA	VR=5V
Luminous Intensity Matching Ratio	I <sub>v-m</sub>	-	-	2:1	-	I <sub>F</sub> =10mA

Notes:The device can not operated under continuous reverse voltage.

**Model No.: CSOS-80100W CSOS-80101W**

**Typical Electrical / Optical Characteristics Curves -**

(Ta = 25°C Unless Otherwise Noted)

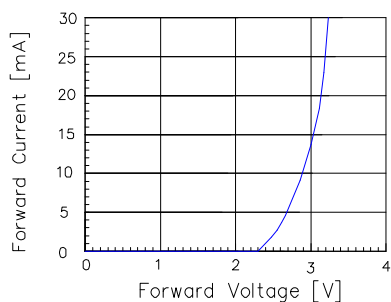

Fig 1. Forward Current vs. Forward Voltage

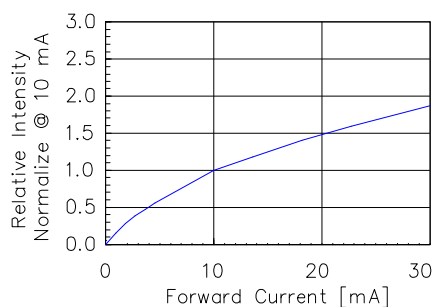

Fig 2. Relative Intensity vs. Forward Current

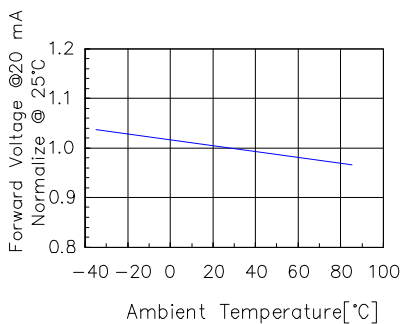

Fig 3. Forward Voltage vs. Temperature

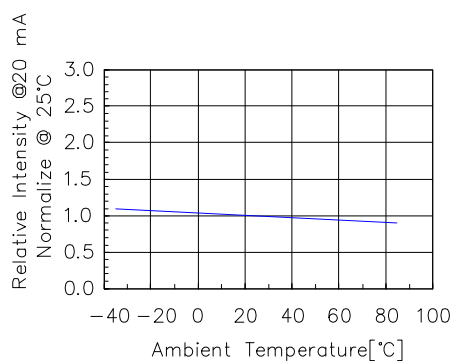

Fig 4. Relative Intensity vs. Temperature

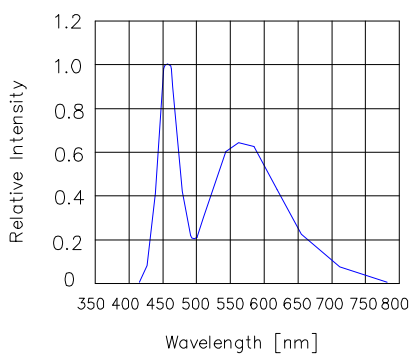

Fig 5. Relative Intensity vs. Wavelength

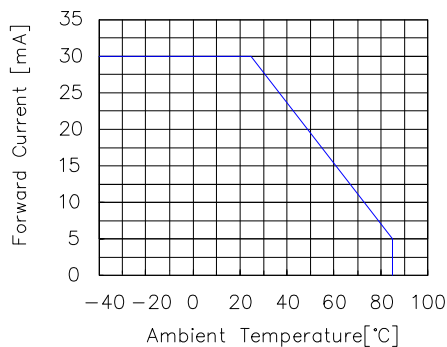

Fig 6. Forward current vs. Temperature

**Model No.: CSOS-80100W CSOS-80101W**

**■ Precautions For Use -**

**1.Wave Soldering Profile**

Distance:1.6mm min(From seating plane)

Item	Condition		Note
Preheat	Temperature T1	80 – 120°C	PWB temperature (Soldering side surface)
	Time t1	60 – 180sec	
Solder Dip	Temperature T2	230 – 260°C	Bath temperature
	Time t2	2 – 4sec	Solder tank passage time

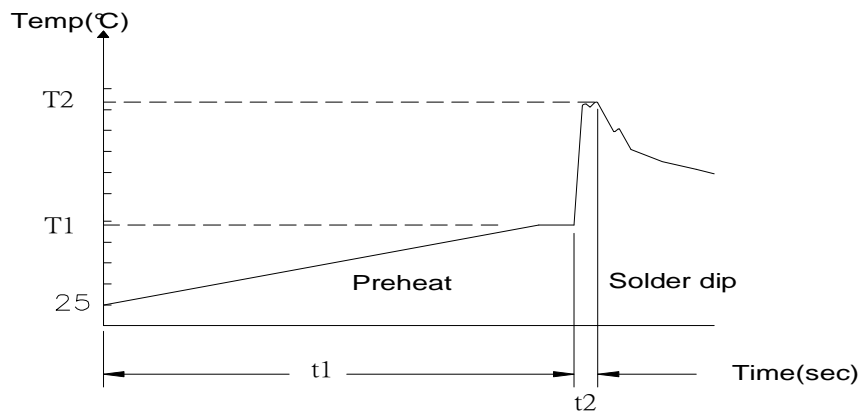

**2.Hand Soldering (Iron Condition)**

Soldering Iron:30W Max

Temperature 350°C Max

Soldering Time:3 Seconds Max(One Time)

Distance:1.6mm min(From seating plane)